

# 49" Outdoor PCAP Freestanding Multi Touch Screen Poster



## PCAP Touch Screen

State-of-the-art projected capacitive technology provides the most responsive and sensitive touch experience available, as well as offering superior optical quality. Unlike other touch technologies, PCAP is not affected by dust or debris on the surface of the screen.



## Vandal Proof











With a 2mm thick mild steel enclosure and 5mm thermally-toughened glass front, these IK10 rated displays are designed to withstand damage that may occur in public spaces. To avoid tampering, controls and inputs are hidden and cannot be accessed by passers-by.

**IK10**

Impact Resistance  
**10** Protected against 20 joules of impact



2mm Steel Enclosure  
 5mm Tough Glass

-  2,500cd/m<sup>2</sup>
-  Weatherproof
-  No Ghost Touch
-  Advanced Temperature Control System
-  Ambient Light Sensor
-  Anti-Reflective Glass
-  Internal Locker
-  24/7 Usage
-  Android Media Player
-  Customisation Available

## Other Features

### Direct Sunlight Readable

Thanks to their commercial grade ultra-high brightness panels (2,500cd/m<sup>2</sup>), these displays are up to 10 times brighter than a domestic TV and so are easily readable even in direct sunlight.



### Weatherproof

Designed to withstand the elements, these displays are protected against all wet weather conditions and airborne dust particles by their robust IP65 rated enclosure. They also feature a waterproof coating on all internal circuit boards and waterproof over-moulded AV connectors.

# IP65

- Dust Resistance**  
6 Protected against dust that may harm equipment.
- Water Resistance**  
5 Protected against water spray from all directions.



### No Ghost Touch

The electrodes that control the interactivity are sandwiched between two layers of special protective glass to prevent phantom touches. This ensures ultimate accuracy and a seamless touch experience.



### Easy Maintenance

These displays use hydraulic cylinders to allow easy front access to the internal components, ensuring that maintenance is simple and straightforward.



### Internal Locker

Should you need run the screen from an external source, there is space to fit a small PC or media player inside the lockable compartment. This can then be connected to the display via the HDMI, VGA or 3.5mm audio inputs.



### Advanced Temperature Control System

To maximise the lifespan of the display, the internal airflow system keeps the screen running at the optimal temperature regardless of the external conditions. Built-in air conditioning can be tailored to allow the display to work in any climate.



### Anti-Reflective Glass

The front glass face is specially treated to help diffuse direct sunlight, making the display easily readable even in bright weather conditions.



### Android Media Player

The display comes with a built in Android media player, which can be updated using our online CMS or be used to install your own Android application.



# Key Features



PCAP TOUCH SCREEN



2,500 CD/M<sup>2</sup>  
SUNLIGHT READABLE



IK10 RATED



IP65 RATED



2MM THICK  
STEEL ENCLOSURE

REMOVABLE BASE

10 TOUCH POINTS

ANDROID MEDIA PLAYER



WEATHERPROOF



AMBIENT LIGHT SENSOR



EASY MAINTENANCE



CUSTOMISATION  
AVAILABLE

## Specification Table

		49 Inch
Panel	Resolution	1080x1920
	Pixel Pitch	0.5592 x 0.5592
	Display Area (mm)	1079.8x610
	Aspect Ratio	16:9
	Brightness (cd/m <sup>2</sup> )	2,500
	Colour	1.06 B
	Viewing Angle	178°
	Contrast Ratio	8000:1
Touch	Touch Technology	Projected Capacitive
	Touch Points	10
	Glass Hardness	7H Minimum
AV Inputs	Video	HDMI, VGA
Power	Power Consumption (W)	300
	Input Voltage	AC110~240V (50Hz~60Hz)
Mechanical	Unit Size (HxWxD mm)	1950x870x182
	Package Size (HxWxD mm)	2070x1050x400
	Footprint (WxD mm)	890x500
	Net Weight (kg)	186
	Gross Weight (kg)	216
	IK Rating	IK10
Environmental	Operating Temperature:	-20 °C to 50 °C
	Operating Humidity:	10% - 80%
	Storage Temperature:	-30°C - 60°C
	Storage Humidity:	5% - 90%
	Enclosure Protection	IP65
Computer	Media Formats	Video (MPG, AVI, MP4, RM, RMVB, TS), Audio (MP3, WMA), Image (JPG, GIF, BMP, PNG)
	Media Resolution	1080x1920
	Internal Memory	6GB
	CPU	Quad-Core Cortex-A9 @1.6GHz
	GPU	Mali-400 MP4 @600MHz
	RAM	1GB DDR3
	Internal Storage	8GB NAND
	USB	USB2.0 HOST (x2)
	LAN	10/100M Ethernet
	Wi-Fi	802.11b/g/n
	OS	Android 4.2.2
Accessories	Graphic Engine	OpenGL ES 1.1/2.0/3.0/3.1, OpenCL 1.1, Renderscript, Direct3D 11.1
	Included	AC Power Cable, Remote Control
Warranty	Optional	Network Upgrade, Camera
	Warranty Period	3 Year Warranty
	Technical Support	Lifetime

Errors and omissions excepted



# Technical Drawing

---

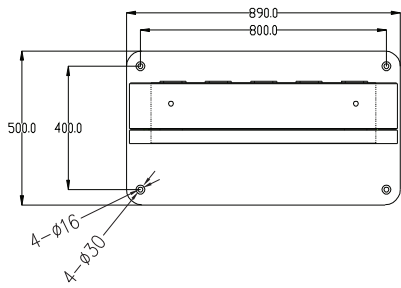
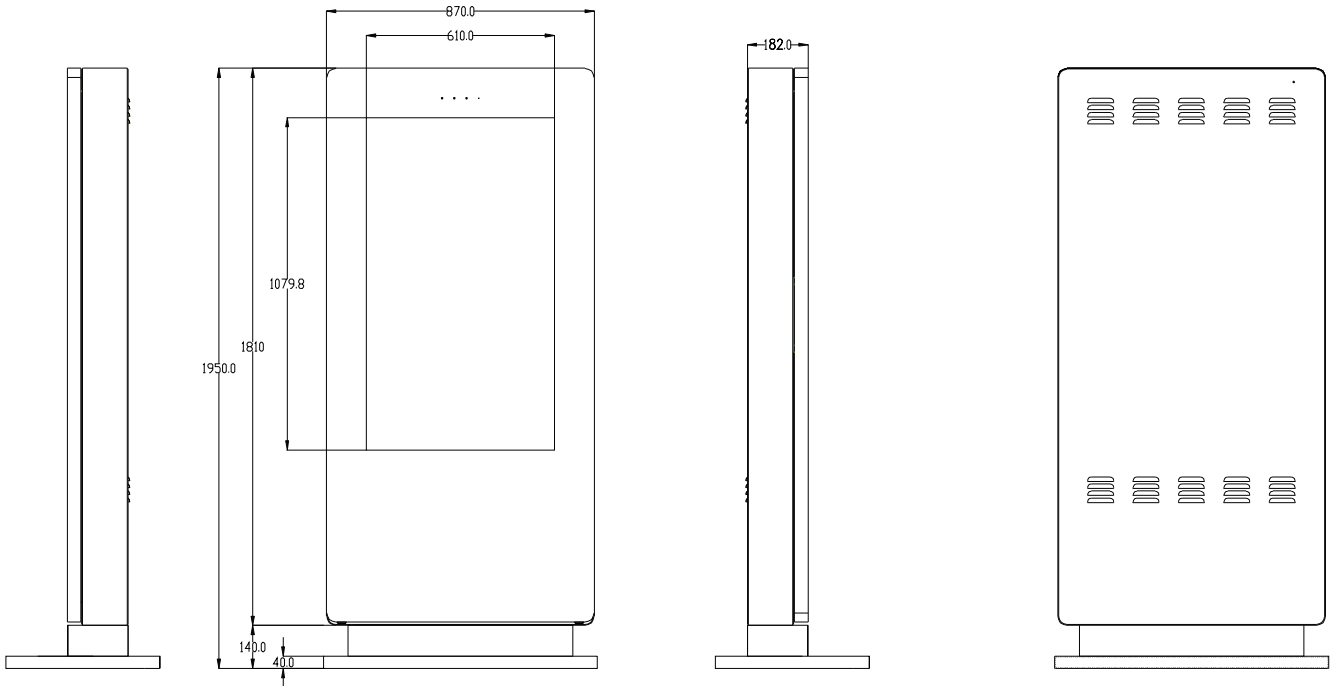

Note: The  $\varnothing 30$  holes are for access, we recommend using M10 anchor bolts that will fit into the  $\varnothing 16$  holes.

---

## Why Choose Our Commercial Display Solutions?



### Lifetime Technical Support

From the moment you receive your product, throughout the duration of your warranty and even after your warranty has expired we are here to support you. If you require any assistance setting up or using your product, or have any problems at all, we can provide free technical support via telephone and email.



### On-site Support and Maintenance\*

If needed, we can provide an installation service for any of our products. We can also set up service-level agreements for larger projects that require maintenance contracts.



### Extended Warranty\*

All of our commercial display products come with a 3 year commercial warranty as standard but if you want to extend this you can upgrade this to cover a 5 year period at point of purchase.



### Training

As well as providing free remote CMS training sessions and webinars we can also visit you to deliver bespoke training for our software and hardware\*.



### Advanced Replacements†

Should your display suffer from any kind of hardware failure during the warranty period we will send you an advanced replacement and arrange for your old display to be collected, free of charge. This ensures no downtime where you are without a screen.



### Custom Product Testing & Configuration

If you need us to test third party software or a website, or configure your screen in a particular way before it is dispatched (e.g. in a particular orientation or network mode), we can do so to make your life easier.



### 3D Rendering

Want to know how a particular screen will look once installed? Send us a photo of the location and we will create a 3D rendering of any screen in situ to help you to visualise how amazing it will look.



### Logistics Support

We hold more stock in our UK warehouse than any other manufacturer so we can help you meet tight deadlines. For last minute orders we can also offer special express or morning delivery options\*. We also carry out UK based quality control checks on every display before it leaves our warehouse.



### Project Support

If you need to loan a sample unit to test we'd be more than happy to arrange this. We can also provide a rental service for temporary projects\*.



### Customisation\*

Your display can be customised to suit your requirements by adding your logo or printed graphics or even tailoring the colour of a display. We can also carry out hardware modifications to existing products or manufacture bespoke solutions for special projects.



### Extras\*

As well as being able to provide accessories and add-ons, such as extra remote controls, NUC PCs and video wall controllers, we can also supply custom made flight cases which are great if a display needs to be moved safely from place to place.

†UK mainland only

\*These particular services may incur additional charges