

## 55" Professional Monitors



Adaptable 24/7 commercial grade AV monitor with simple digital signage media player

### Budget Friendly Professional Displays

These displays are designed to be a cost effective 24/7 commercial display solution. If your application calls for a commercial screen and budget is a major factor these displays are perfect.



### 450cd/m<sup>2</sup> IPS Panel

Commercial grade IPS technology accurately displays image quality and colour depth with no fall-off in colour accuracy. These panels are designed to achieve ultimate lifelike colour temperature when used in either landscape or portrait.



### 24/7 Commercial Use

These displays use a commercial grade LCD panel and LED backlight. They have the ability to be in constant use 24/7 for over 70,000 hours and have no external buttons or controls to avoid tampering.



### Narrow Bezel

A slim border helps draw attention to the screens images and not the display for maximum impact messaging. Thanks to the narrow bezel these monitors can also be used as part of a budget friendly video wall.



## Other Features

### Plug and Play

Plug and Play is the most straightforward way to upload content to the screen. Simply load images and videos onto a USB stick and insert into the display; your images and videos will now play in a continuous loop.

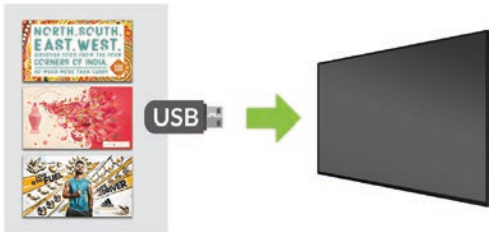

### Built-in Video Matrix Processor

Automatically tile an external signal without the need for an expensive matrix box, creating a budget-friendly video wall solution.



### Power Timer

The eco-friendly power timer allows you to assign daily or weekly on and off times for your screen meaning that it is only in use when it needs to be; improving your environmental efficiency.



### Low Power Consumption

The LED backlight technology provides improved brightness and contrast. Their lifespan is drastically improved to over 70,000 hours and the power consumption is reduced by around 30%.

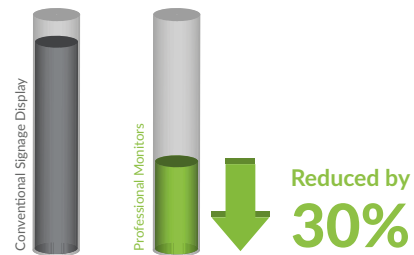

### Wide Viewing Angle

Thanks to the IPS technology these displays provide fantastic image quality with a remarkable viewing angle of 178° in both landscape and portrait.



### Connect Devices

Should you need to use the screen as a monitor you can connect it to an external source, like a PC or media player, using the HDMI input or the VGA and 3.5mm audio jack inputs.

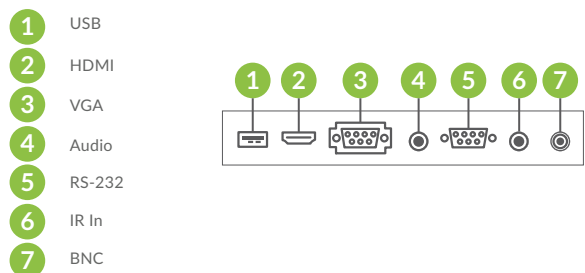

### BNC Connection

Ideal for CCTV monitor applications our monitors have a BNC input for AV connections. The monitor is able to display video directly from CCTV cameras or from a Digital Video Recorder.



### RS-232 Control and IR Extension

Remotely control your screens by sending commands over RS-232 or use the free infrared remote control sensor extension for easier kiosk integration.

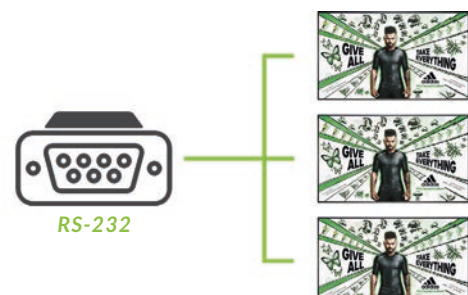

# Key Features



PLUG AND PLAY

# VIPS

IPS PANEL



24/7 COMMERCIAL GRADE



LED BACKLIGHT



NARROW BEZEL

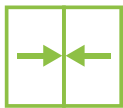

CONNECT DEVICES

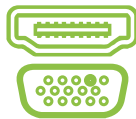

LANDSCAPE OR PORTRAIT ORIENTATION



FULL HIGH DEFINITION 1080P

# HD

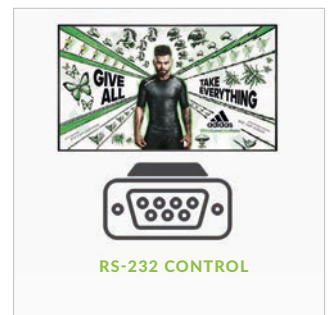
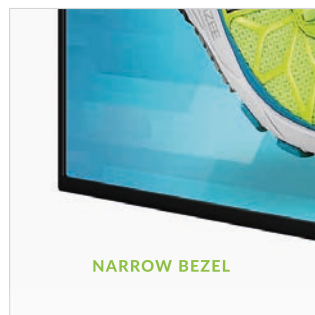

## Specification Table

|               |                                 | 55 Inch   |
|---------------|---------------------------------|---|
| Panel         | Resolution                      | 1920x1080   |
|               | Display Area (mm)               | 1209.6x680.4  |
|               | Bezel Size (mm)                 | Top/left/right: 8.9, Bottom: 15                             |
|               | Pixel Pitch                     | TBC   |
|               | Aspect Ratio                    | 16:9  |
|               | Brightness (cd/m <sup>2</sup> ) | 450   |
|               | Colour                          | 16.7M   |
|               | Viewing Angle                   | 178°  |
| Audio         | Contrast Ratio                  | 1200:1  |
|               | Speaker Type                    | 2W, 8Ω (x2)   |
| AV Inputs     | Video                           | HDMI, VGA, Audio Socket (3.5mm), BNC (AV)                   |
|               | Control                         | RS-232  |
| Power         | Power Consumption (W)           | 98  |
|               | Input Voltage                   | AC110~240V (50Hz~60Hz)                                      |
| Mechanical    | Unit Size (WxHxD mm)            | 1232x708.9x49.9   |
|               | Package Size (WxHxD mm)         | 1360x830x188  |
|               | VESA Holes (mm)                 | 400x200 M6  |
|               | Net Weight (kg)                 | 18.2  |
|               | Gross Weight (kg)               | 24.8  |
| Environmental | Operating Temperature           | 0 °C to 40 °C   |
|               | Storage Temperature             | -10°C to 55°C   |
|               | Operating Humidity              | 10% to 80%  |
|               | Storage Humidity                | 10% to 90%  |
| Computer      | Media Formats                   | Video (AVI, MP4), Audio (MP3), Image (JPG, BMP)             |
|               | Media Resolution                | 1920x1080/1080x1920   |
| Accessories   | Included                        | Remote Control, User Manual                                 |
|               | Optional                        | Wall Mount, Floor Stand/Trolley, Ceiling Mount, Table Stand |
| Warranty      | Warranty Period                 | 3 Year Warranty   |
|               | Technical Support               | Lifetime  |

Errors and omissions excepted



# Technical Drawing

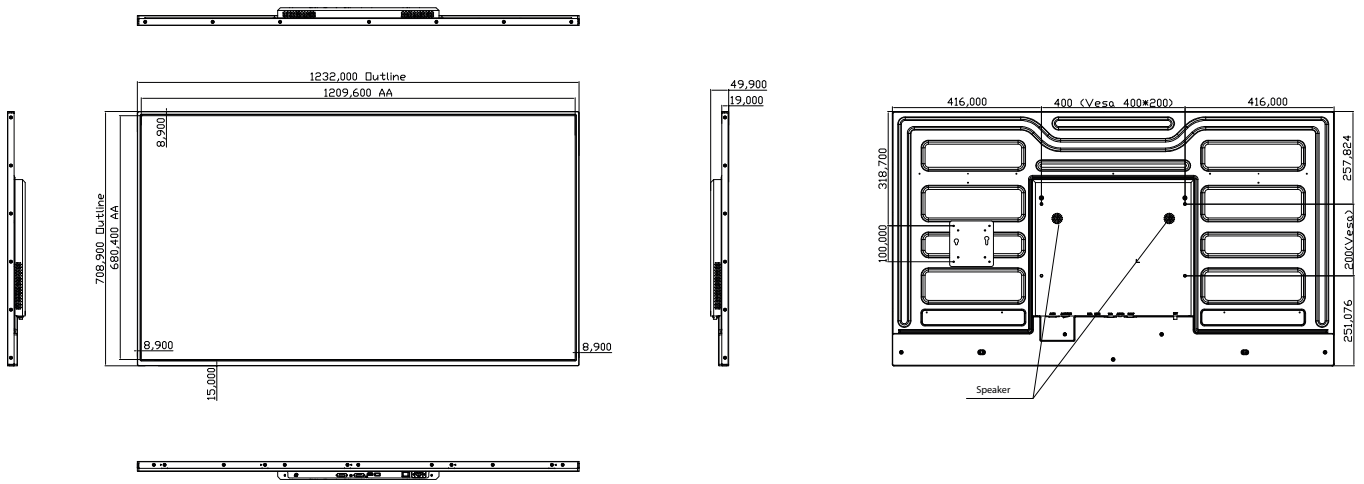

# Why Choose Our Commercial Display Solutions?



## Lifetime Technical Support

From the moment you receive your product, throughout the duration of your warranty and even after your warranty has expired we are here to support you. If you require any assistance setting up or using your product, or have any problems at all, we can provide free technical support via telephone and email.



## On-site Support and Maintenance\*

If needed, we can provide an installation service for any of our products. We can also set up service-level agreements for larger projects that require maintenance contracts.



## Extended Warranty\*

All of our commercial display products come with a 3 year commercial warranty as standard but if you want to extend this you can upgrade this to cover a 5 year period at point of purchase.



## Training

As well as providing free remote CMS training sessions and webinars we can also visit you to deliver bespoke training for our software and hardware\*.



## Advanced Replacements†

Should your display suffer from any kind of hardware failure during the warranty period we will send you an advanced replacement and arrange for your old display to be collected, free of charge. This ensures no downtime where you are without a screen.



## Custom Product Testing & Configuration

If you need us to test third party software or a website, or configure your screen in a particular way before it is dispatched (e.g. in a particular orientation or network mode), we can do so to make your life easier.



## 3D Rendering

Want to know how a particular screen will look once installed? Send us a photo of the location and we will create a 3D rendering of any screen in situ to help you to visualise how amazing it will look.



## Logistics Support

We hold more stock in our UK warehouse than any other manufacturer so we can help you meet tight deadlines. For last minute orders we can also offer special express or morning delivery options\*. We also carry out UK based quality control checks on every display before it leaves our warehouse.



## Project Support

If you need to loan a sample unit to test we'd be more than happy to arrange this. We can also provide a rental service for temporary projects\*.



## Customisation\*

Your display can be customised to suit your requirements by adding your logo or printed graphics or even tailoring the colour of a display. We can also carry out hardware modifications to existing products or manufacture bespoke solutions for special projects.



## Extras\*

As well as being able to provide accessories and add-ons, such as extra remote controls, NUC PCs and video wall controllers, we can also supply custom made flight cases which are great if a display needs to be moved safely from place to place.

†UK mainland only

\*These particular services may incur additional charges